

# Product Specification

08/2018

---

<b>Product</b>	TFT Display
<b>Mode</b>	APT TFT <a href="#">750C-Bluetooth</a>
<b>Abbreviation</b>	<a href="#">750C</a>

---

<b>Client</b>	
<b>Customer</b>	
<b>audit</b>	

---

<b>Supplier</b>	Tianjin APT Science and Technology Co., Ltd.  1001, Building 5 HuaDing, No.1 HuaKe 3 Road, Binhai hi-tech Industrial Development Zone, Tianjin, China
<b>Tel</b>	TEL:+86 22 83715556 FAX:+86 22 83719955
<b>Email</b>	<a href="mailto:yzhao@aptdevelop.com">yzhao@aptdevelop.com</a>

## 1. Product Name

- ◇ TFT display
- ◇ Model : APT TFT [750C-Bluetooth](#)

## 2. Suppliers

- ◇ Tianjin APT Science and Technology Co., Ltd.
- ◇ Email : [yzhao@aptdevelop.com](mailto:yzhao@aptdevelop.com) [apt@aptdevelop.com](mailto:apt@aptdevelop.com)

## 3. Electrical Parameters

- ◇ 3.2inch IPS screen
- ◇ 24V/36V/48V/[52V](#) battery supply
- ◇ Rated operating current : 40mA
- ◇ Off leakage current < 1uA
- ◇ Max output current to controller : 100mA
- ◇ Operating temperature : -20~70℃, Storage temperature : -30~80℃

## 4. Dimensions & Material

- ◇ Product shell is ABS, transparent window is made with high strength Acrylic.
- ◇ Dimensions : host/L [110mm](#)\*W[68.2mm](#)\*H[68mm](#)



## 5. Features

- ◇ Suitable for low temperature, Max -20℃.
- ◇ High-contrast 3.2inch IPS colorful matrix screen.
- ◇ Ergonomic external button design, easy to operate.
- ◇ **Speed display:** AVG SPEED, MAX SPEED, SPEED (Real-time).
- ◇ **Kilometer / Mile:** Can be set according to customers' habits.
- ◇ **Smart battery indicator:** Provide a reliable battery indicator.
- ◇ **9-level Assist :** 3-level/5-level/9-level /UBE (6-level) optional.
- ◇ **Mileage indicator:** Odometer/ Trip distance/ Clock/ Riding time.
- ◇ **Power indicator:** real time power indicator, digital or analog.
- ◇ **6km walking**
- ◇ **Bluetooth & Mobile navigation**
- ◇ **Phone battery indicator**
- ◇ **Error code indicator.**
- ◇ **Software upgraded:** Software can be upgraded through UART.

## 6. TFT screen instructions

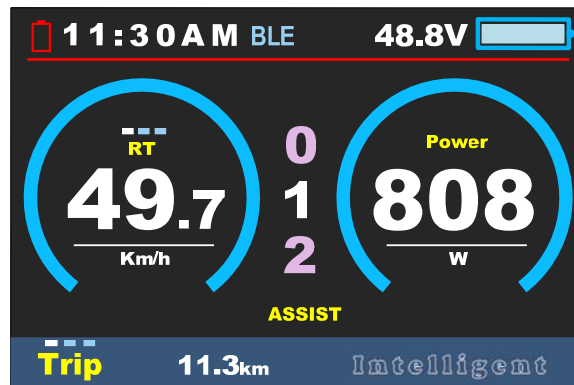

## 7. Functional Description

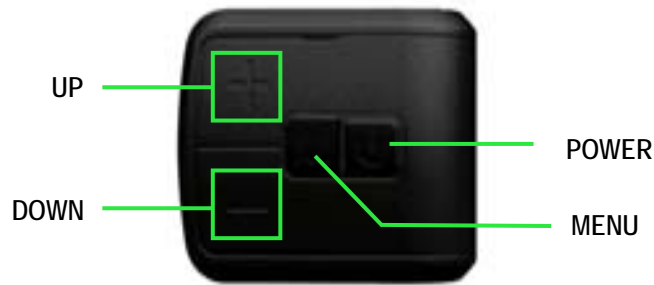

### 7.1 Power On/Off

Press and hold **Power** button for 1 second can turn on/off the display. The Display can automatically shut down when there is no operate & ride for X minutes (X could be 0~9) .

\*If the display has been set password power on, you need to input the right password before start.

### 7.2 Assist level operating

Short press **UP/DOWN** button can change the assist level. Top assist level is 9, 0 for neutral. Level quantities can be adjusted according to the customer requirements.

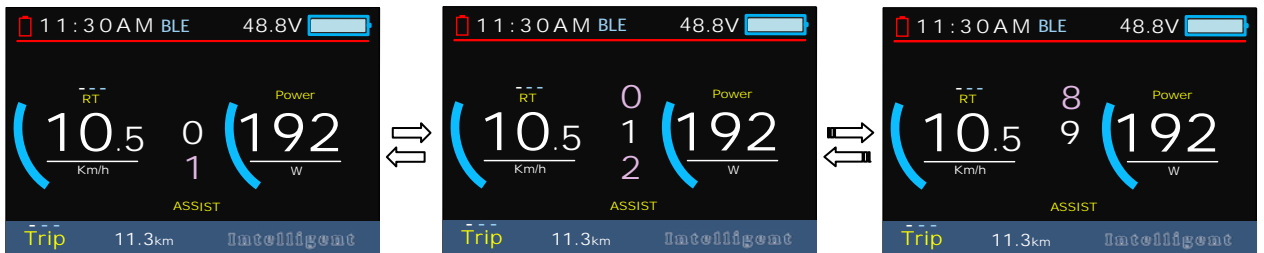

### 7.3 Speed mode switch

Short press **MENU** button can change the speed mode, **Speed**->**AVG Speed**->**MAX Speed**.

\*If there is no operation for 5 seconds, display will return Speed (Real-Time) display automatically.

### 7.4 Mileage mode switch

Short press **POWER** button can change the mileage mode, Trip->ODO-> Time.

### 7.5 Headlight/backlight On/Off

Press and hold **UP** button for 1 second can turn on/off the headlight, and the scree will switch to the corresponding mode.

\*The motor does not work when the battery voltage is low, Display still can keep the headlight on for a while when E-bike is in riding.

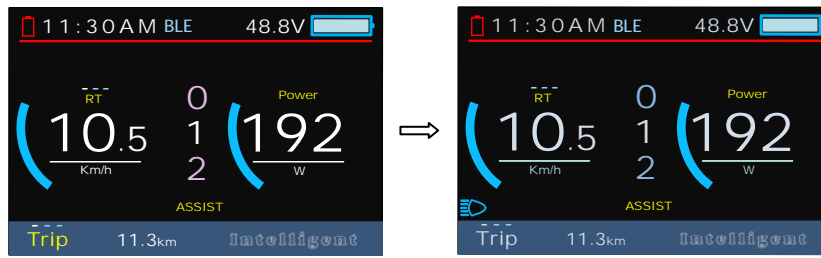

Daytime mode

night mode

## 7.6 Walking mode (6km)

Press and hold **DOWN** button for 2 second can get into walking mode, out of the mode when release the button.

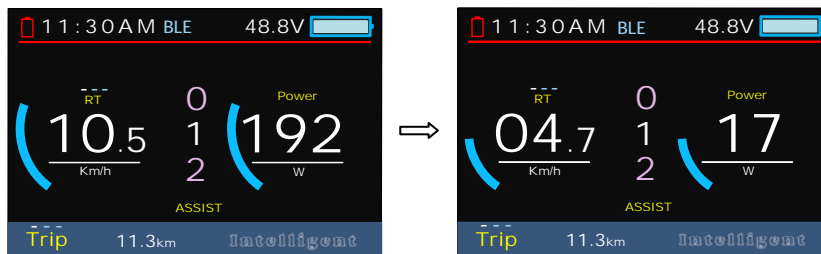

\* This feature needs to be supported by controller.

## 7.7 Bluetooth & mobile navigation

- After installing the I-bike mobile app, turn on the Bluetooth function of the mobile phone, open the I-bike app, set the Scenes item in the instrument menu settings to **“Navigation”**, click **Search for device**, the Meter name defaults to **APTTEST**, and the icon is red, the icon **BLE** is light blue (unconnected state).

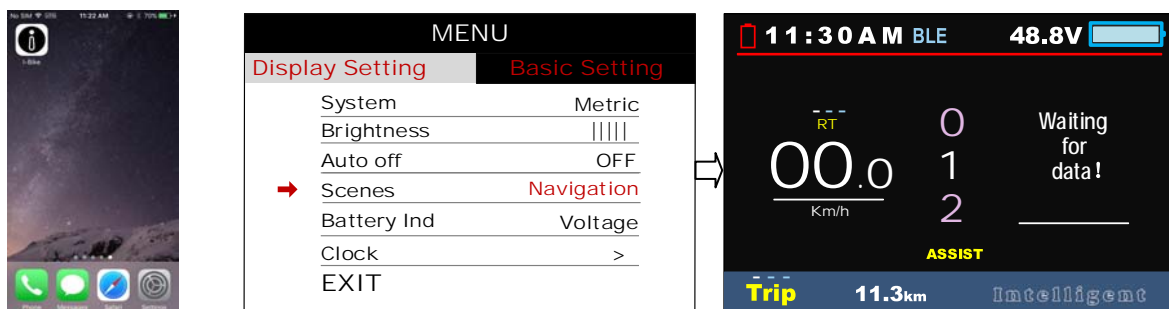

- Connect the phone and meter: Find the meter by mobile phone, search for the meter name **“APTTEST”**, click **search the device**, input these digits in the mobile phone when the 6 digits appear on the meter, click pair and after the successful pairing, the main interface of the mobile phone

displays the I-bike information interface of the meter, and the MAIN interface, the navigation interface (Navi) and the more information interface (More). The meter displays the battery indicator of the phone, and the icon BLE is dark blue (connected).

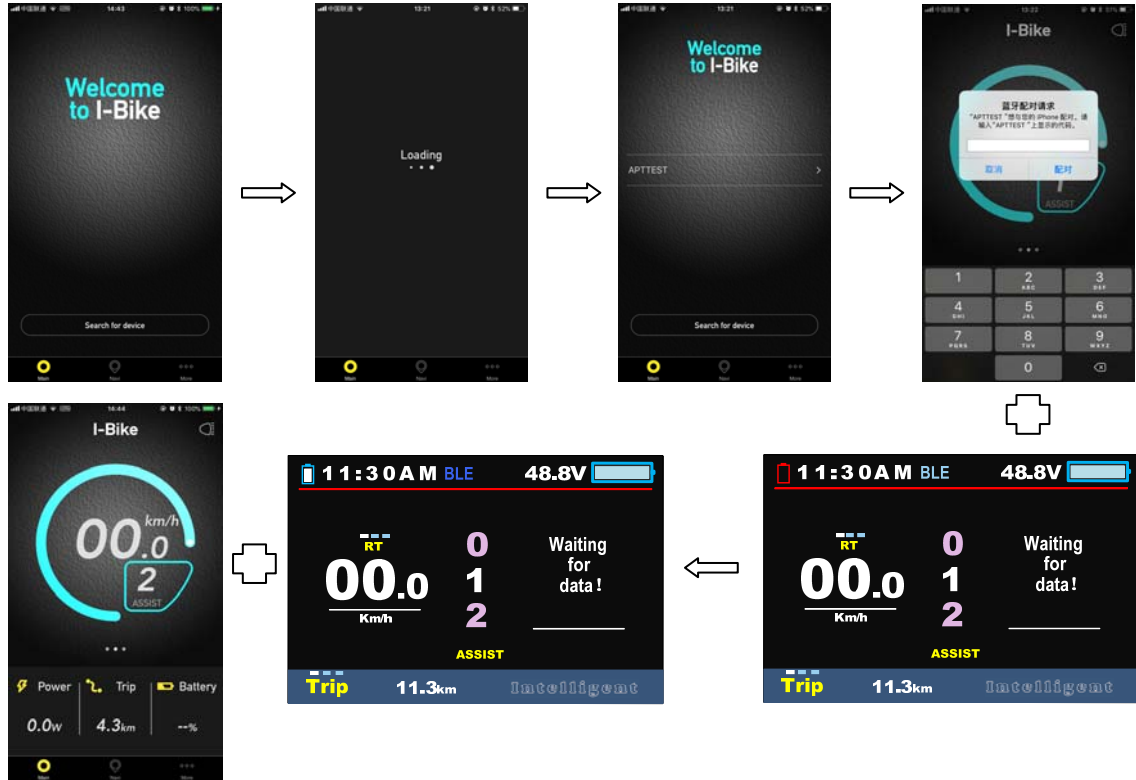

- (3) In the mobile navigation interface, enter Location and choose destination, then the mobile phone displays the map navigation path, distance and usage time information. After clicking **start**, the meter displays the navigation icon  ,  or  and distance information.

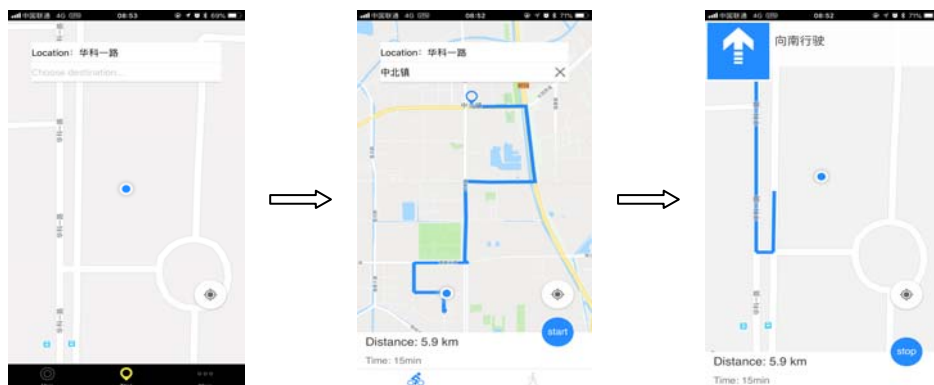



#### (4) Mobile phone I-bike interface display information.

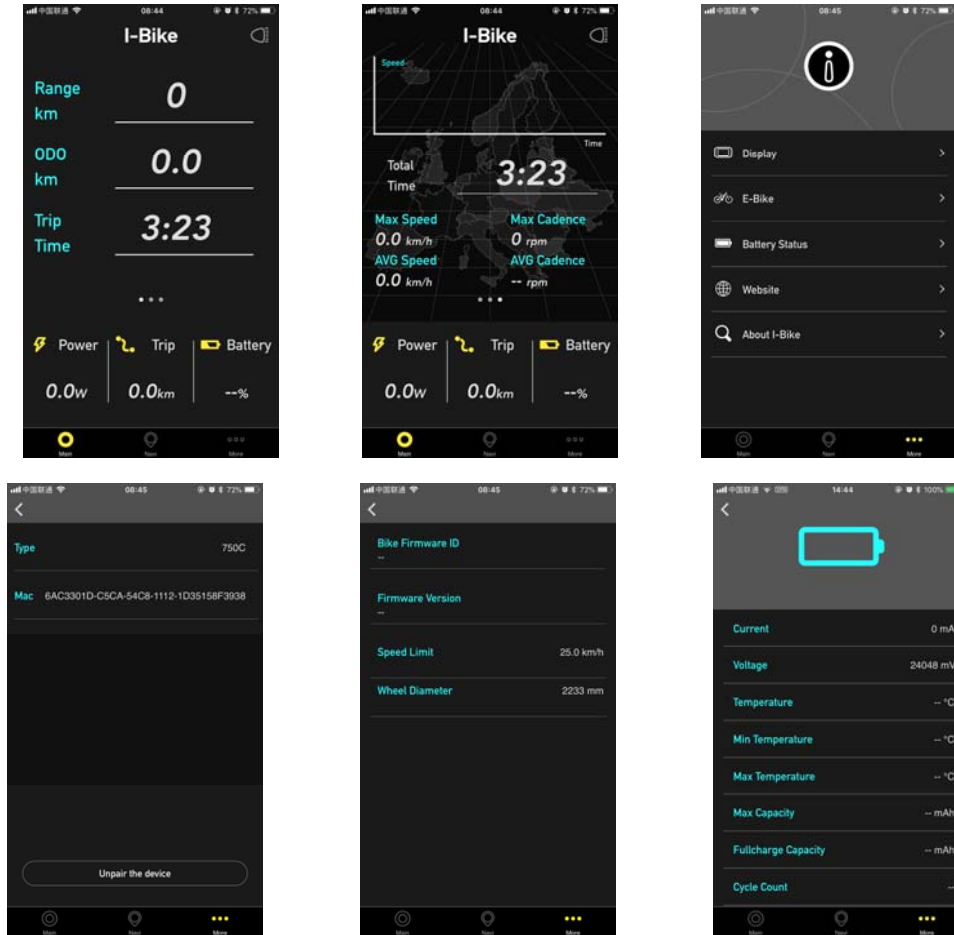

### 7.8 Data cleanup

Press and hold **UP** & **DOWN** buttons together for 1 second can reset several temporary data, temporary data include **AVG Speed / MAX Speed / Trip / Time**.

\* These temporary data can't be erased by power off.

## 8. Parameter setting

Double press **MENU** button (press interval less than 0.3 second) can get into setting menus, press **POWER** button to change **Display Setting / Basic setting**, press **UP/DOWN** buttons to change the parameter setting, press **MENU** button can switch to next item. Double press

**MENU** button will exit from menu.

- \* Display will automatically quit menu when there is no operation for 30 seconds.
- \* For safety reasons, display can't get into MENU when riding.
- \* Display will quit MENU when start riding.

The order of parameters are as follow.

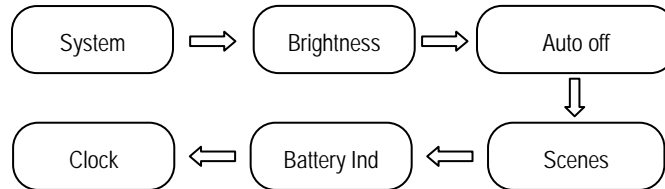

**8.1 System** : Press Up / Down button to switch between Metric / Imperial.

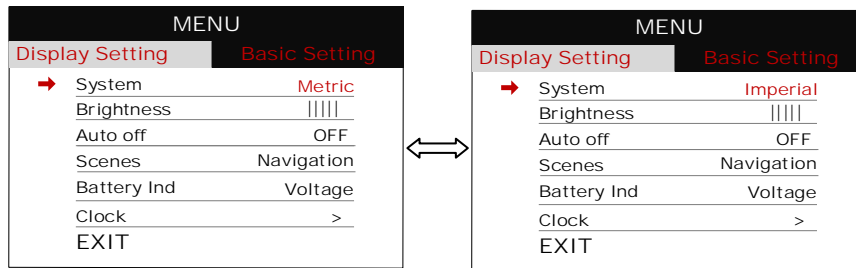

**8.2 Brightness** : Press Up / Down button to change the brightness of the backlight, | is darkness, ||||| is brightness. The daytime mode defaults to |||||, and the night mode defaults to ||.

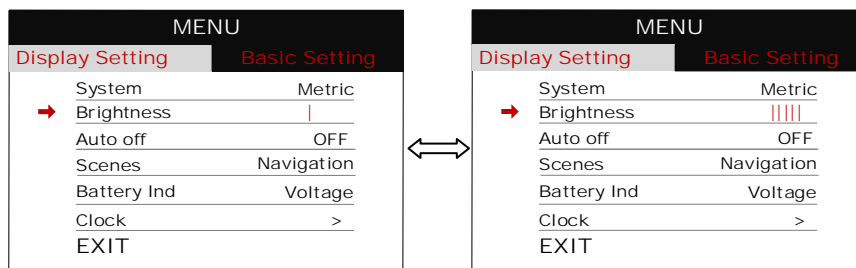

**8.3 Auto off** : Press UP/DOWN button to change the auto power off time, from 1 to 9 or OFF, the number represent time (minutes) to shutdown, default value is 5 minutes.

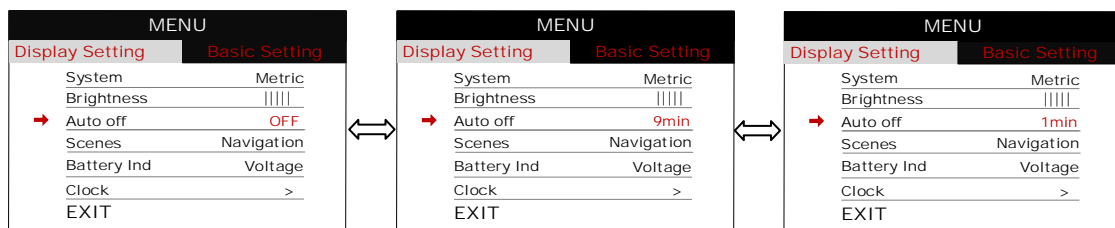

**8.4 Scenes**: Press UP/DOWN button to change the scenes, Navigation / M-power.



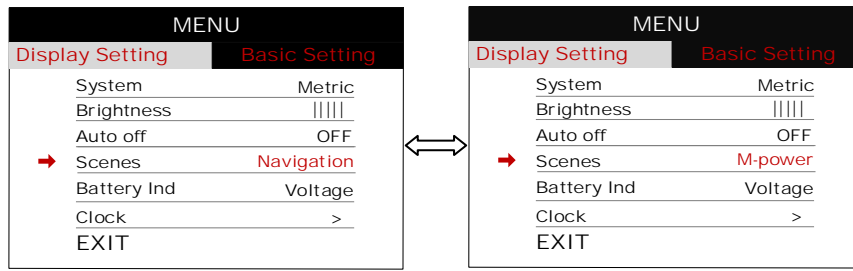

**8.5 Battery Ind** : Press UP/DOWN button to change the battery indicator, Voltage / Percentage / OFF.

\*Accurate percentage needs communication with battery.

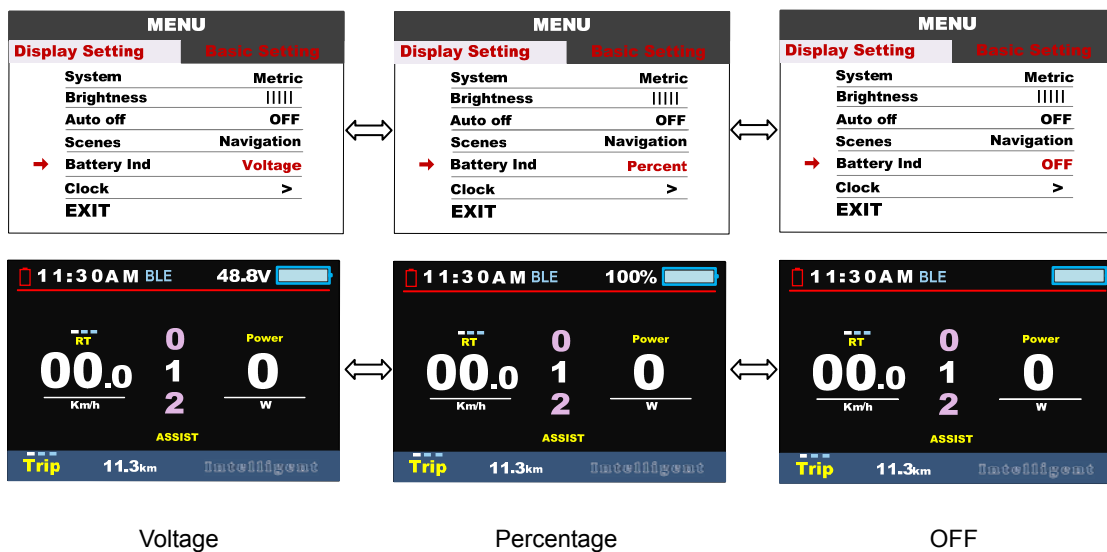

**8.6 Clock** : Clock setting, press **MENU** button get into the clock setting menu, press UP/DOWN button to set Year/Month/Day/Hour/Min/Sec.

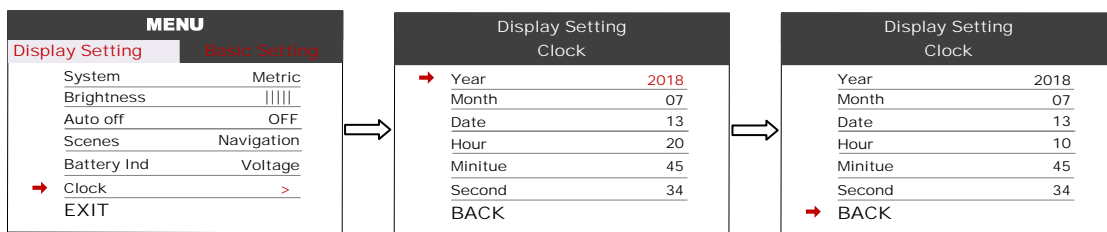

**Basic Setting**

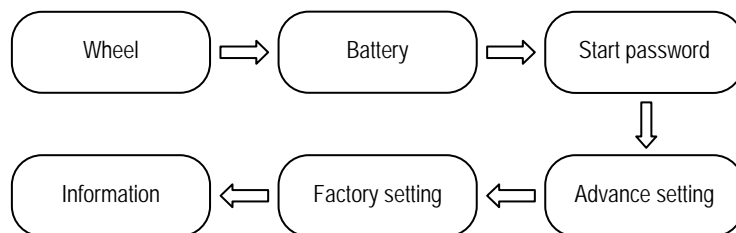

**8.7 Wheel** : Press UP/DOWN can change the wheel setting, optional wheel diameter is 16/18/20/22/24/26/27/27.5/28/29/30/31 inch, 51cm~255cm represent wheel circumference (this needs controller support).

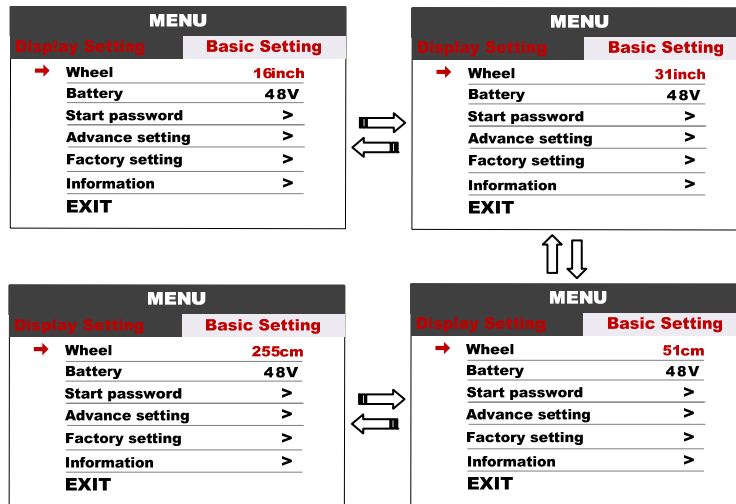

**8.8 Battery** : Press UP/DOWN will change battery voltage setting, optional value is 24V/36V/48V/UBE, UBE means user define value.

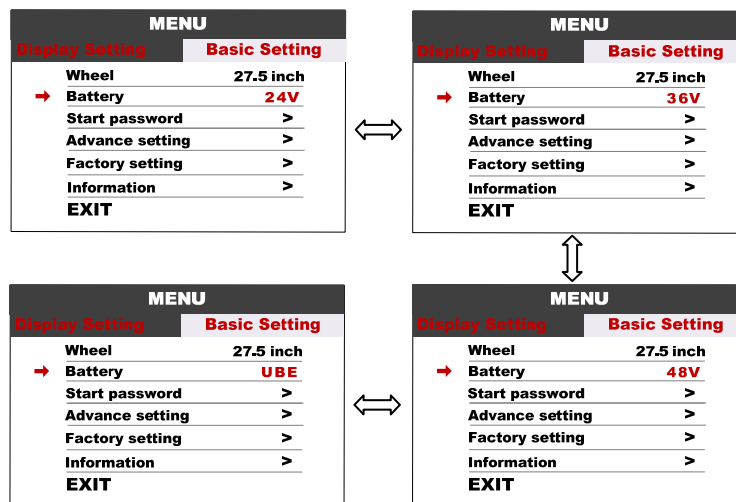

**8.9 Start password** : Press **MENU** button get into the password setting menu. If you had set Start input **ON**, you must input right password before power on, password is accorded to your setting.

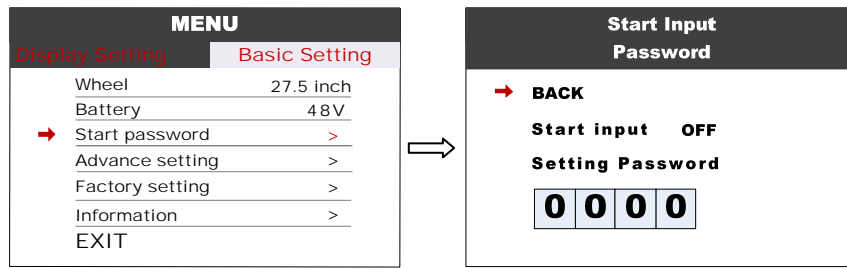

You need to input the right password before start with 30 seconds, display will power off automatically if the password was wrong three times.

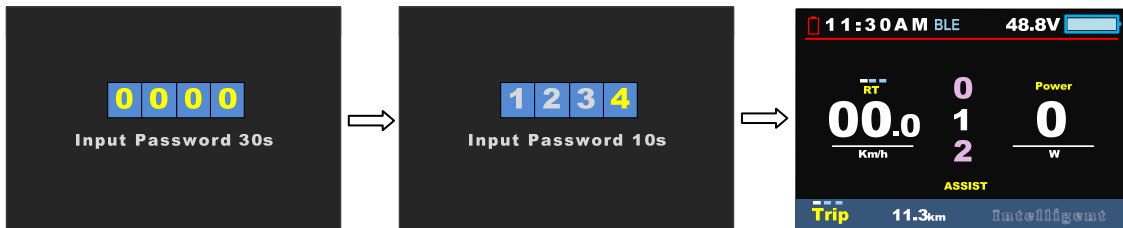

**8.10 Advance setting:** Press **MENU** button can get into the advance setting menu, default password is '1919'.

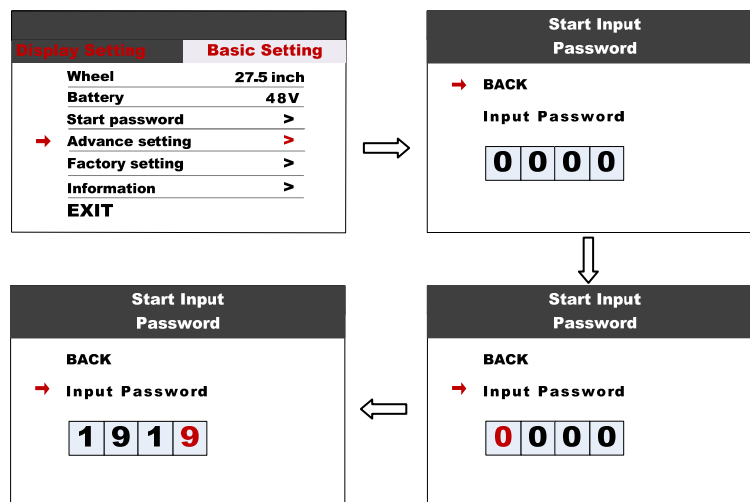

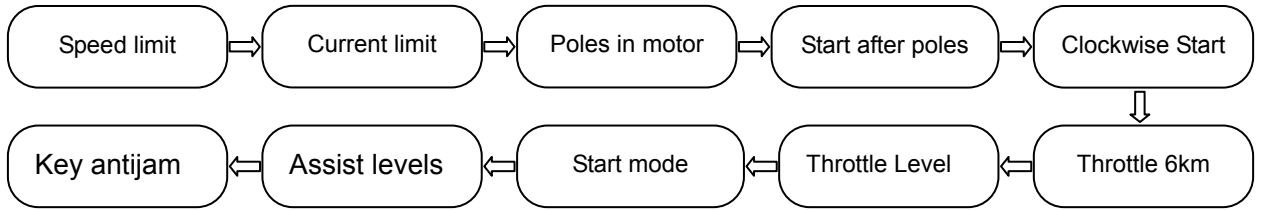

**8.11 Speed limit** : Press UP/DOWN will change speed limit, range 10km/h~60km/h.  
Default value is 25km/h.

Advance Setting	
→ Speed limit	10km/h
Current limit	15A
Poles in motor	1
Start affter poles	3
Clockwise Start	Y
Throttle 6km	N
NEXT PAGE	
EXIT	

Advance Setting	
→ Speed limit	25km/h
Current limit	15A
Poles in motor	1
Start affter poles	3
Clockwise Start	Y
Throttle 6km	N
NEXT PAGE	
EXIT	

Advance Setting	
→ Speed limit	60km/h
Current limit	15A
Poles in motor	1
Start affter poles	3
Clockwise Start	Y
Throttle 6km	N
NEXT PAGE	
EXIT	

\*Speed limit and current limit are restricted by controller and motor

**8.12 Current limit** : Press UP/DOWN will change current limit, range 6A~50A. Default value is 15A.

Advance Setting	
Speed limit	25km/h
→ Current limit	06A
Poles in motor	1
Start affter poles	3
Clockwise Start	Y
Throttle 6km	N
NEXT PAGE	
EXIT	

Advance Setting	
Speed limit	25km/h
→ Current limit	15A
Poles in motor	1
Start affter poles	3
Clockwise Start	Y
Throttle 6km	N
NEXT PAGE	
EXIT	

Advance Setting	
Speed limit	25km/h
→ Current limit	50A
Poles in motor	1
Start affter poles	3
Clockwise Start	Y
Throttle 6km	N
NEXT PAGE	
EXIT	

**8.13 Poles in motor** : Magnetic poles inside the motor, press UP/DOWN will change pole number, range 0~15.

Advance Setting	
Speed limit	25km/h
Current limit	15A
→ Poles in motor	0
Start affter poles	3
Clockwise Start	Y
Throttle 6km	N
NEXT PAGE	
EXIT	

Advance Setting	
Speed limit	25km/h
Current limit	15A
→ Poles in motor	1
Start affter poles	3
Clockwise Start	Y
Throttle 6km	N
NEXT PAGE	
EXIT	

Advance Setting	
Speed limit	25km/h
Current limit	15A
→ Poles in motor	15
Start affter poles	3
Clockwise Start	Y
Throttle 6km	N
NEXT PAGE	
EXIT	

**8.14 Start after poles** : How many poles (speed sensor) need to be detected by controller before starting motor. Default value is 3.

Advance Setting	
Speed limit	25km/h
Current limit	15A
Poles in motor	1
→ Start affter poles	1
Clockwise Start	Y
Throttle 6km	N
NEXT PAGE	
EXIT	

Advance Setting	
Speed limit	25km/h
Current limit	15A
Poles in motor	1
→ Start affter poles	2
Clockwise Start	Y
Throttle 6km	N
NEXT PAGE	
EXIT	

Advance Setting	
Speed limit	25km/h
Current limit	15A
Poles in motor	1
→ Start affter poles	3
Clockwise Start	Y
Throttle 6km	N
NEXT PAGE	
EXIT	

**8.15 Clockwise start** : This parameter represent speed sensor turn direction, default value is Y (forward).

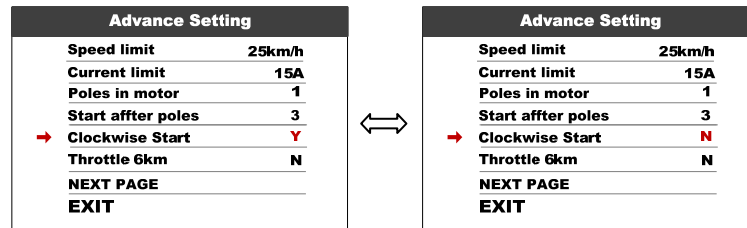

**8.16 Throttle 6km** : this parameter can set the throttle function, N represent max speed, Y represent 6Km.

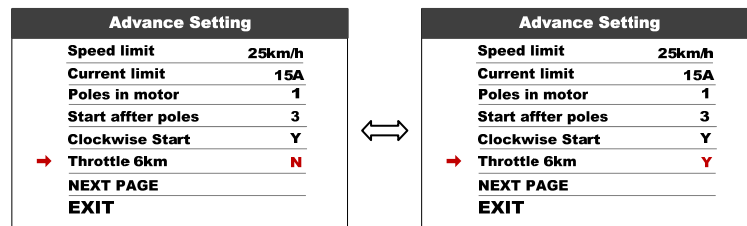

**8.17 Throttle Level** : This parameter is functional when Throttle 6KM set N, Press UP/DOWN will change Y/N, N represent Throttle start max speed, Y represent throttle's speed is accorded to the assist level.

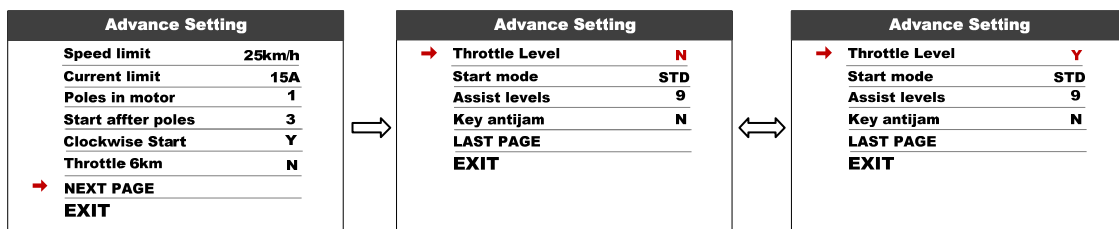

**8.18 Start mode** : Pow/ECO/STD represent Power/ECO/Standard, STD (default). Power mode means use maximum current when speed up, ECO mode means use minimum current.

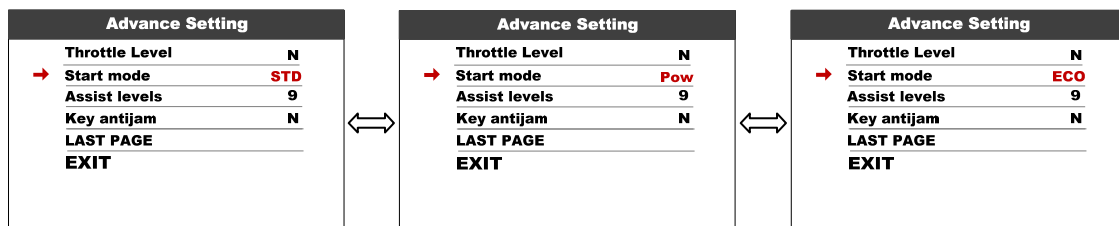

\*This function is optional, may not supported by each mode.

**8.19 Assist levels** : This parameter can customize assist levels, options are 3/5/9/UBE, UBE represent factory default settings.

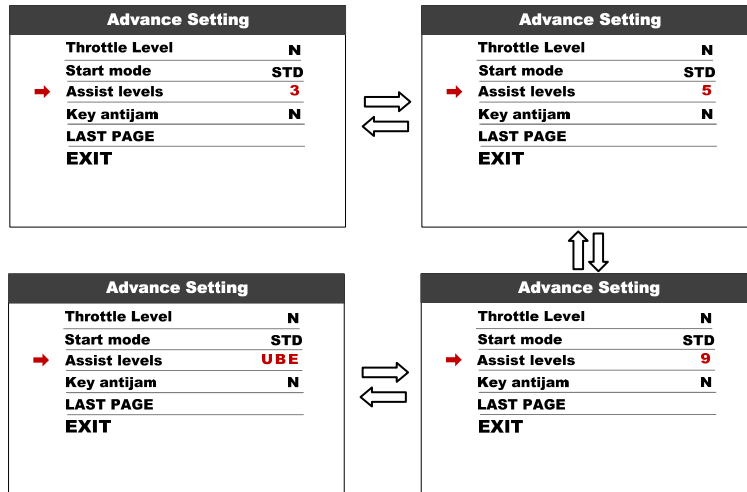

8.20 **Key antijam:** Key antijam N/Y, default value is N (OFF).

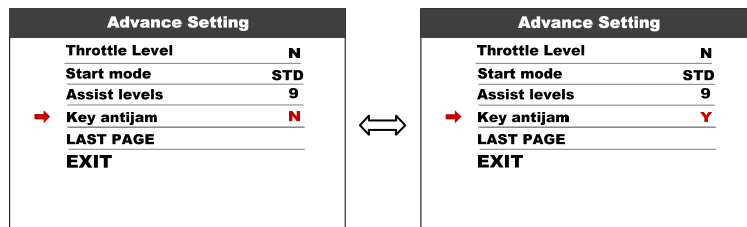

8.21 **Factory setting:** Press **MENU** button enter Restore Factory Settings item, set YES will restore all parameter to factory settings.

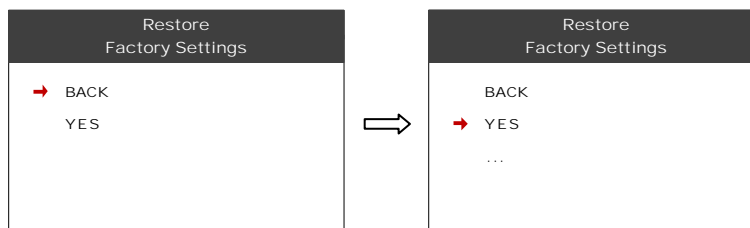

8.22 **Information:** Show information of the E-bike.

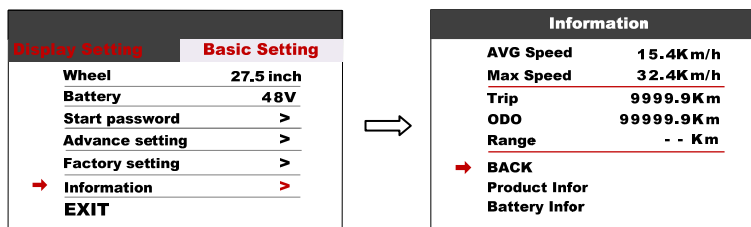

8.23 **Product info:** Get into this item can show hardware version software version...

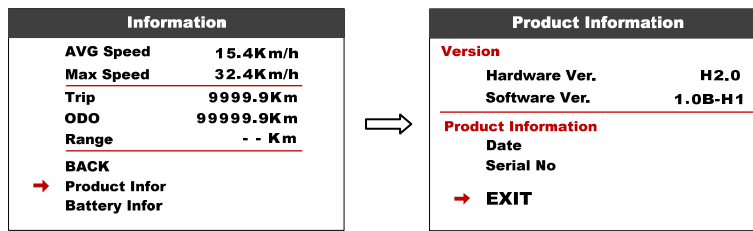

**8.24 Battery info** : Get into this item can show all information of battery, including Voltage, Capacity. [Cycle times, Health, Temperature of battery, Remaining Capacity, Full Charge Capacity, these items are invalid.]

\*These information needs to be supported by battery communication.

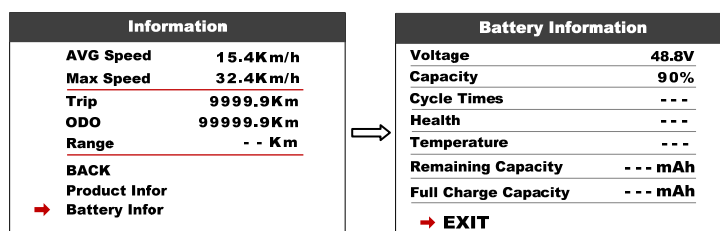

## 9. Error Code define

750C can show warning message, icon shows on the screen, and show error code at the bottom of the screen, error code from 01~07, definition see the table below.

Error Code	Error description	Handle
01	Communication Error	Check the cable connection
02	Controller protection	Check three-phase power line.
03	three-phase power error	Check three-phase power line connection
04	Battery low	Charge the battery
05	Brake error	Check the brake connection.
06	Throttle error	Check turn to connect.
07	Hall error	Check the hall connection
08-99	Reserved	Please contact the manufacturer for error definitions

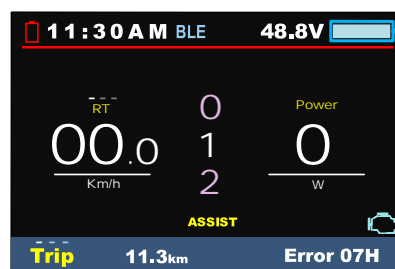
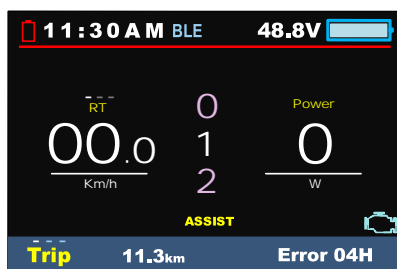

## 10. Assembly instructions

Please pay attention to the screw's torque value, damaged caused by excessive torque is not within the scope of the warranty.

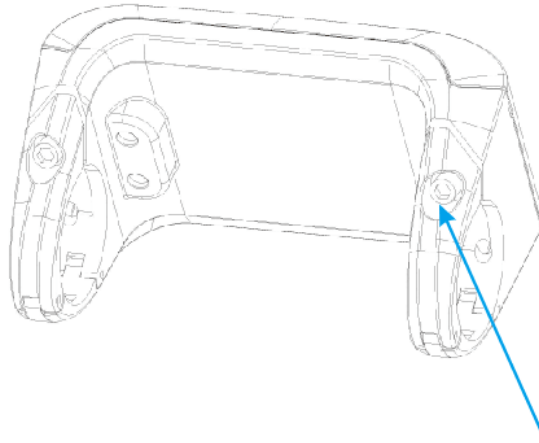

M4\*10  
STD=0.1N.M  
MAX=0.2NM



M3\*8  
STD=0.25N.M  
MAX=0.4N.M

Clamps suit for 3 size of handlebar, 31.8mm, 25.4mm, 22.2mm, there are transfer rings for 25.4mm and 22.2mm (marked with L or R), transfer ring must be assembled with the special directions, pay attention to the green arrow below.



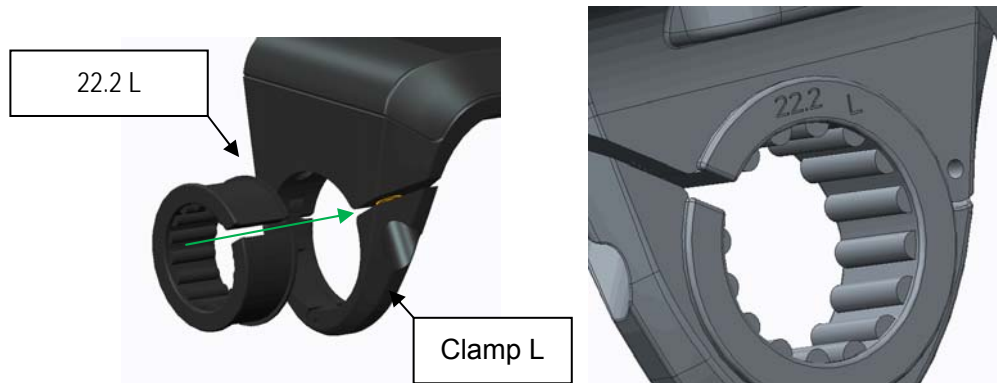

## 11. Connector descriptions

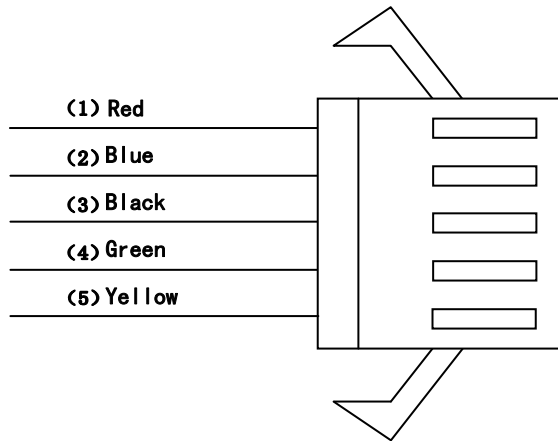

- 1、 Red wire : Anode(24v/36v/48V/52V)
- 2、 Blue wire : Power cord to the controller
- 3、 Black wire : GND
- 4、 Green wire : RxD (controller -> display)
- 5、 Yellow wire : TxD (display -> controller)

## 12. Assist level instructions

Assist level can be customized, the highest level is 9, common used assist level see the table below:

3 level	5 level	9 level	UBE (6level)	
0	0	0	0	No power assist
		1	1	
	1	2		
1		3	2	
	2	4		
2		5	3	

---

	3	6		
		7	4	
	4	8	5	
3	5	9	6	

### 13. Certification

CE / IP65 (water proof) / ROHS.