Product Specification

2013-08-15

Product: Super thin LED display

Model: APT350U

Customer Type:350U

Client:

Customer

audit:

Supplier: Tianjin APT Science and Technology Co., Ltd.

1001, Building 5 HuaDing, No.1 HuaKe 3 Road, Binhai hi-tech
Industrial Development Zone, Tianjin, China

TEL: TEL:+86 22 26345859

FAX:+86 22 83719955

EMAIL yzhao@aptdevelop.com

Approval:

1 Summary

1.1 Product Name:

Super thin LED display display



4-cell waterproof connector



1.2 Product Type:

APT350U

1.3 Supplier

Tianjin APT Science and Technology Co., Ltd.

1.4 Functional description

✧ Voltage:24V、36V

- ✧ UART communicate with controller
- ✧ PAS level 0-3, 0 means no power assist
- ✧ Smart battery indicator
- ✧ WALKING mode (6km)
- ✧ Headlight control
- ✧ Automatically adjust LED brightness
- ✧ Rated operating current :30mA
- ✧ Max operating current : 50mA
- ✧ Output current to the controller : 50mA
- ✧ Off leakage current < 1uA
- ✧ Operating temperature: -10 ~ 60 °C.
- ✧ Storage Temperature: -20 ~ 80 °C.

1.5 Display's film icon

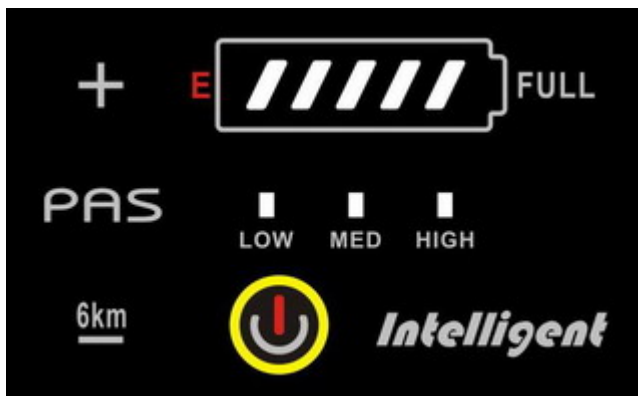

2 Introductions





2.1 Battery indicator:











2.2 PAS level display



3 Functional introduction

- ✧  button : Open / close the vehicle power.
- ✧  button : Press the button to increase the PAS level.
- ✧  button : Press the button to decrease the PAS level.
- ✧  button : Press and hold this button for 1 seconds to turn on/off the light. Automatically reduce the LED brightness when then the light is on,
- ✧  button : Press and hold this button for 1 seconds to enter the WALK mode.

4 Voltage setup

Press and hold button  when turn on the display (press ) , the display get into voltage setup state, **LOW** led is twinkling , press  button to setup the voltage (press and hold button  at the same time), 2 lights of the battery indicator turn on means 24V , 3 lights of the battery indicator turn on means 36V , release the  button will finish setup.

5 Assembly instructions

Please pay attention to the screw's torque value, damaged caused by excessive torque is not within the scope of the warranty.

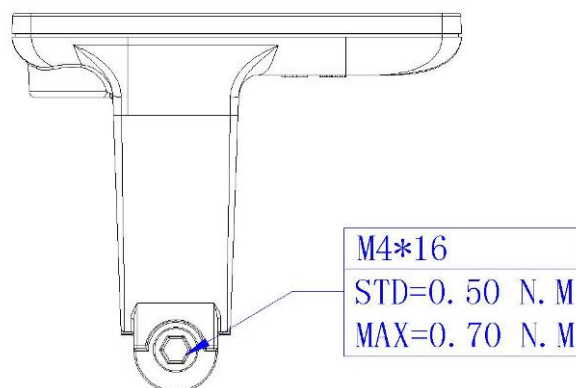

6 Output wire instructions

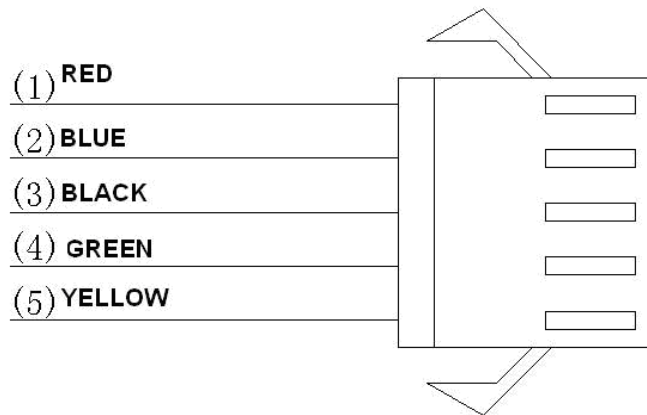

- 1、 Red wire : Anode(24v/36v)
- 2、 Blue wire : Power cord to the controller
- 3、 Black wire : GND
- 4、 Green wire : RxD (controller -> display)
- 5、 Yellow wire : TxD (display -> controller)

7 Certification

CE / IP65 (water proof) / ROHS.